

KIA Niro (EV) all-electric		2019-2022	
			1/11



GB Location/Position Arrow









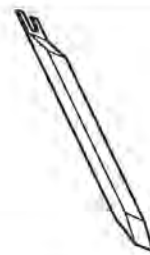
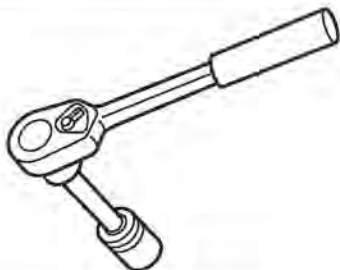
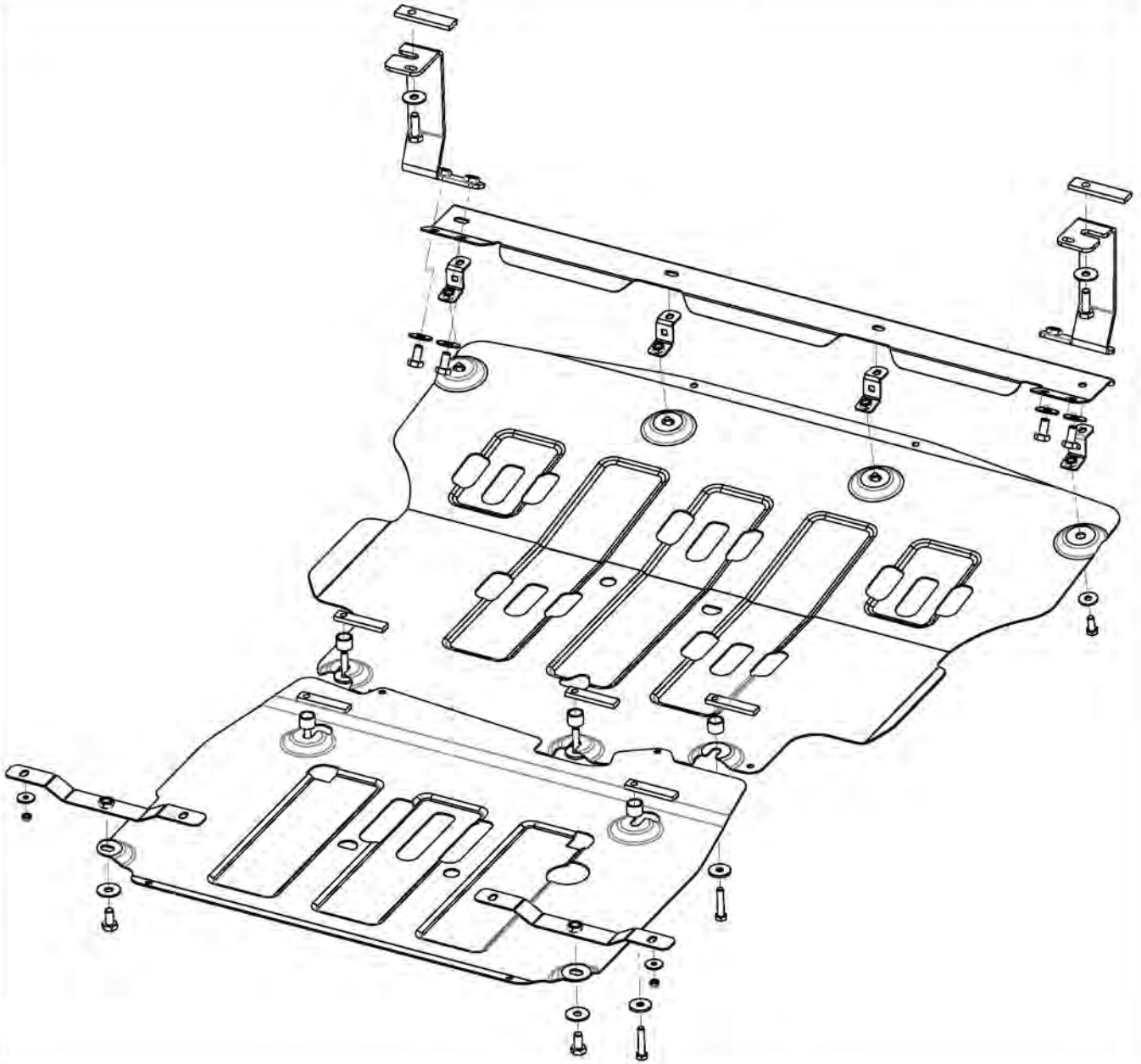

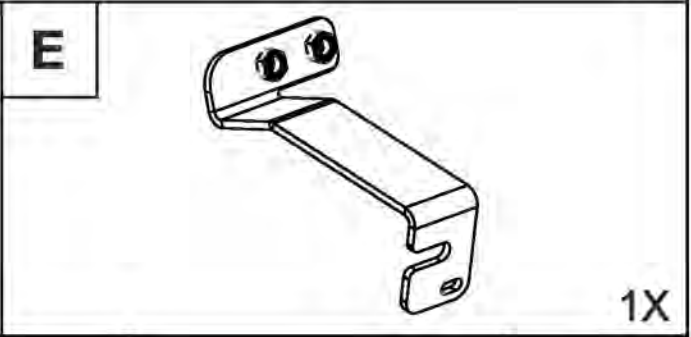
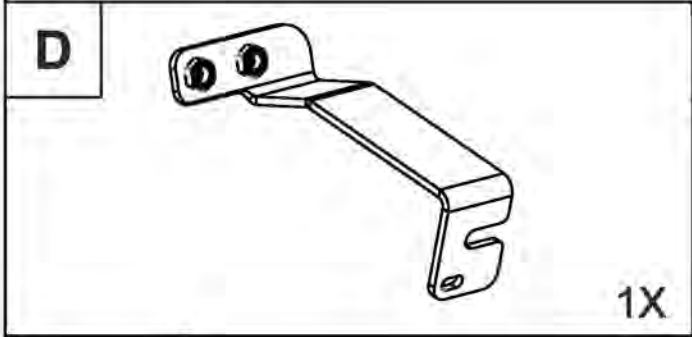
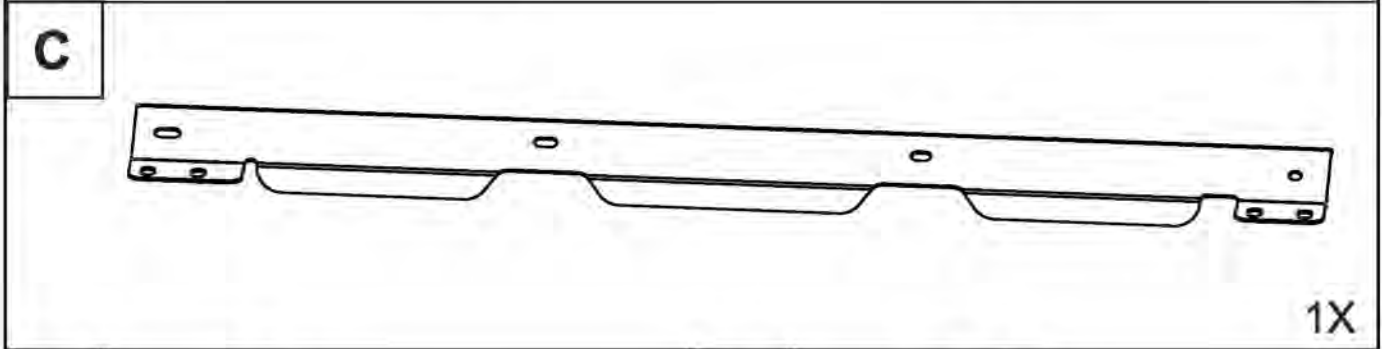
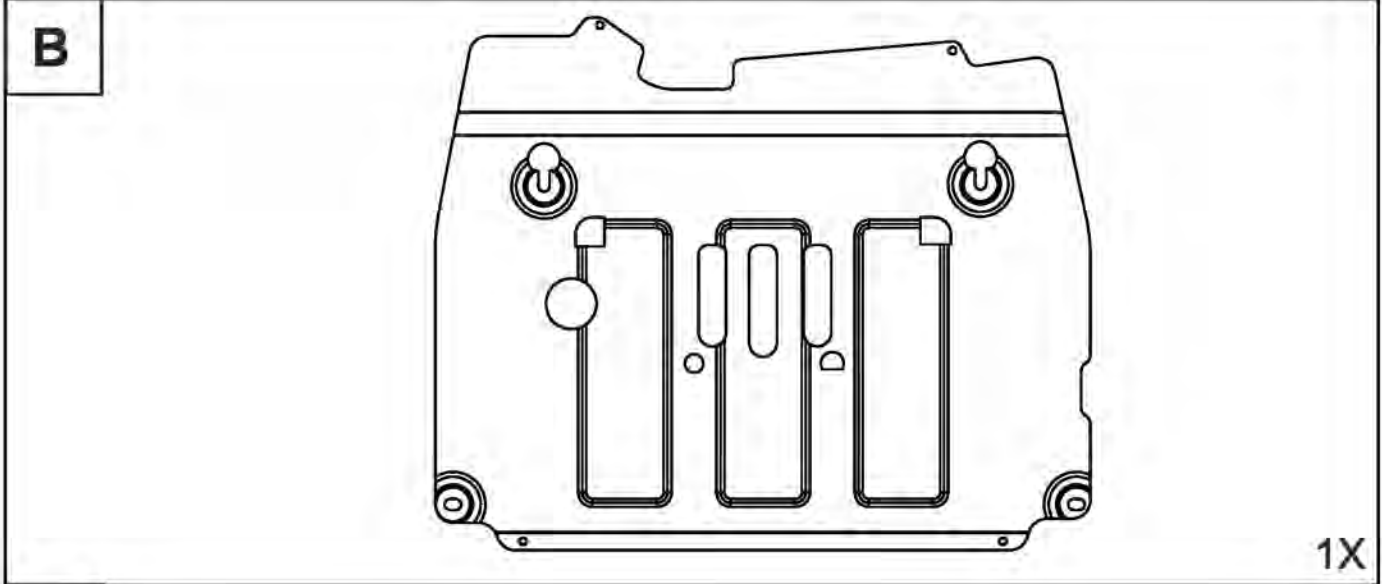
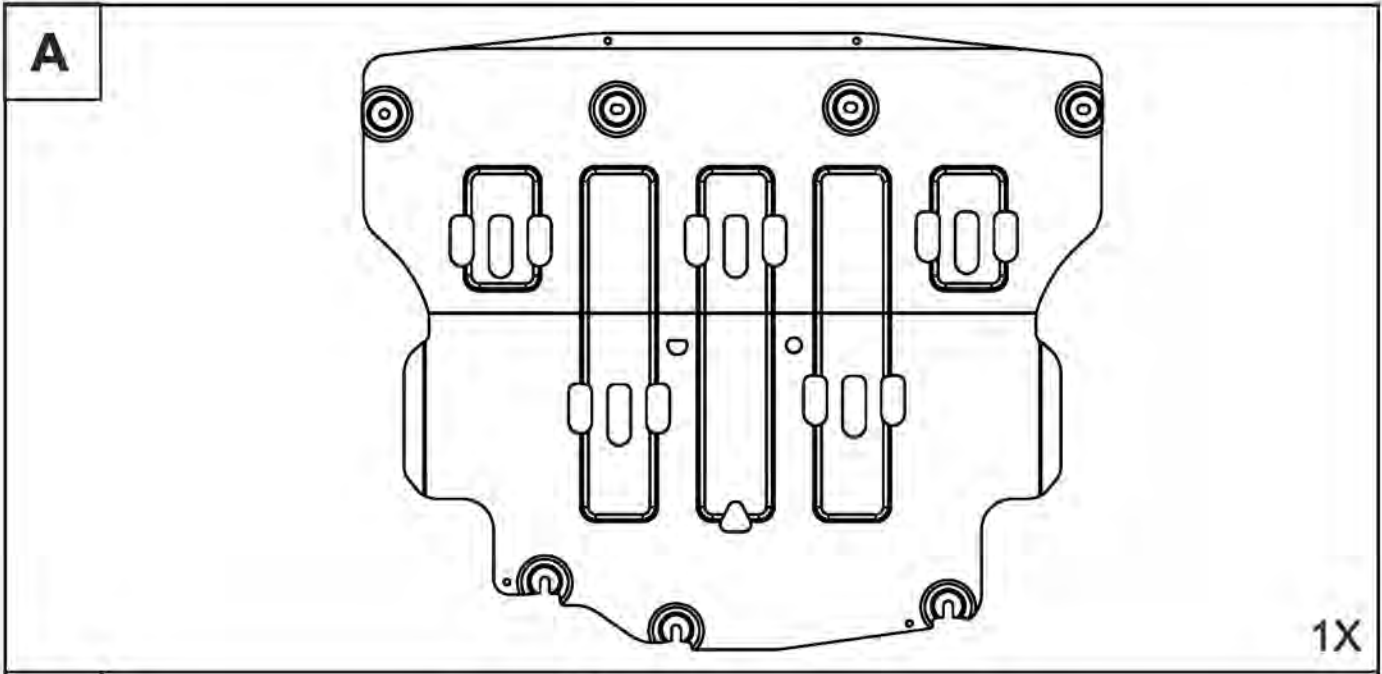

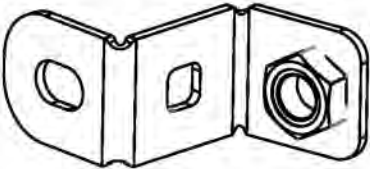

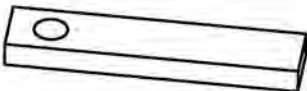
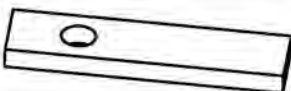
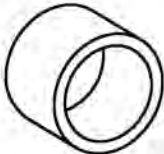
GB Movement Arrow



GB Screw Arrow





F 	<p>4X</p>	G 	<p>2X</p>
H 	<p>5X</p>	I 	<p>2X</p>
J 	<p>5X</p>	K 	<p>M8x20 4X</p>
L 	<p>2X</p>	M 	<p>M8x40 5X</p>
N 	<p>5X</p>	O 	<p>M10x20 6X</p>
P 	<p>4X</p>	Q 	<p>M10x30 2X</p>
R 	<p>8X</p>	S 	<p>M6 2X</p>
			<p>4/11</p>

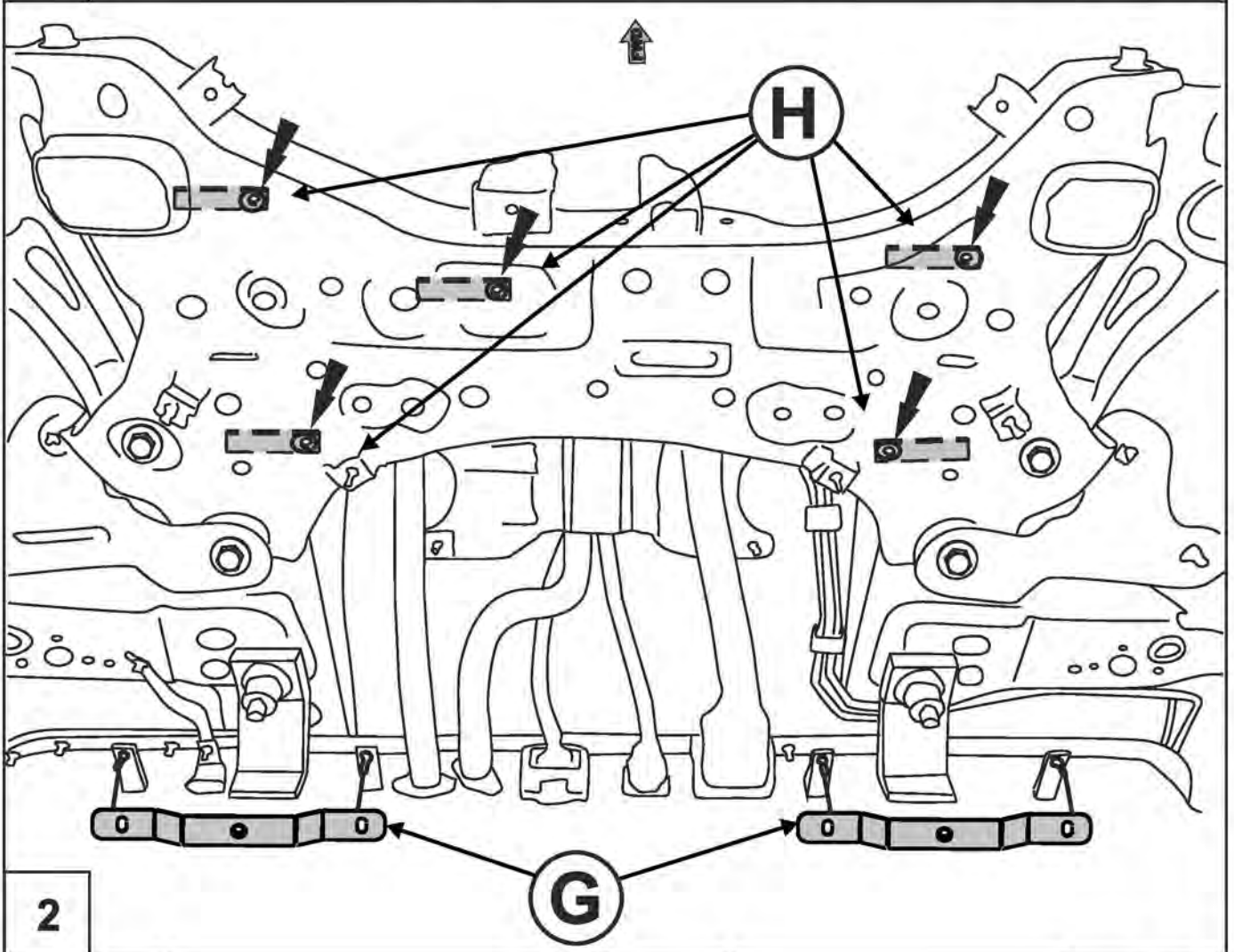
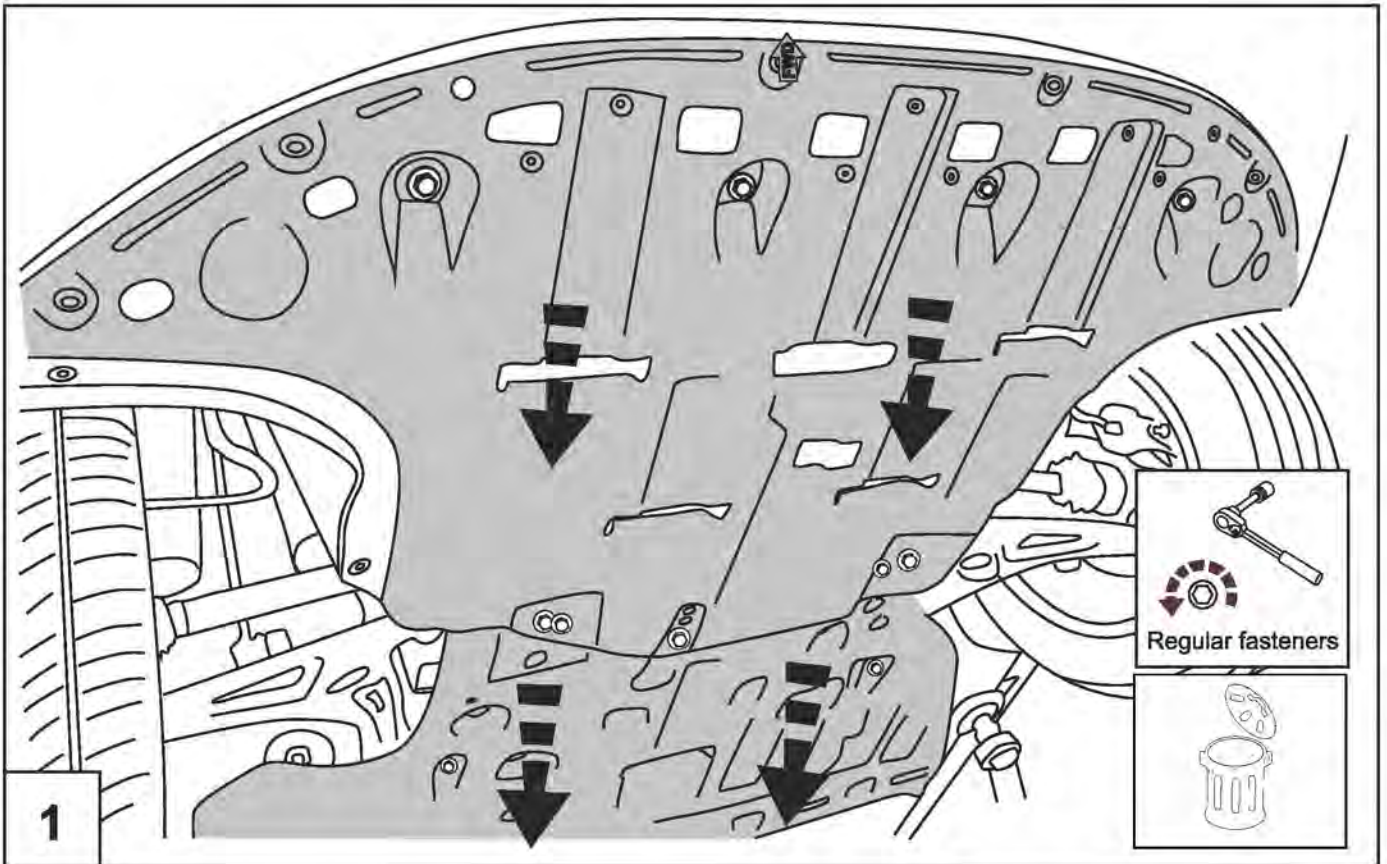

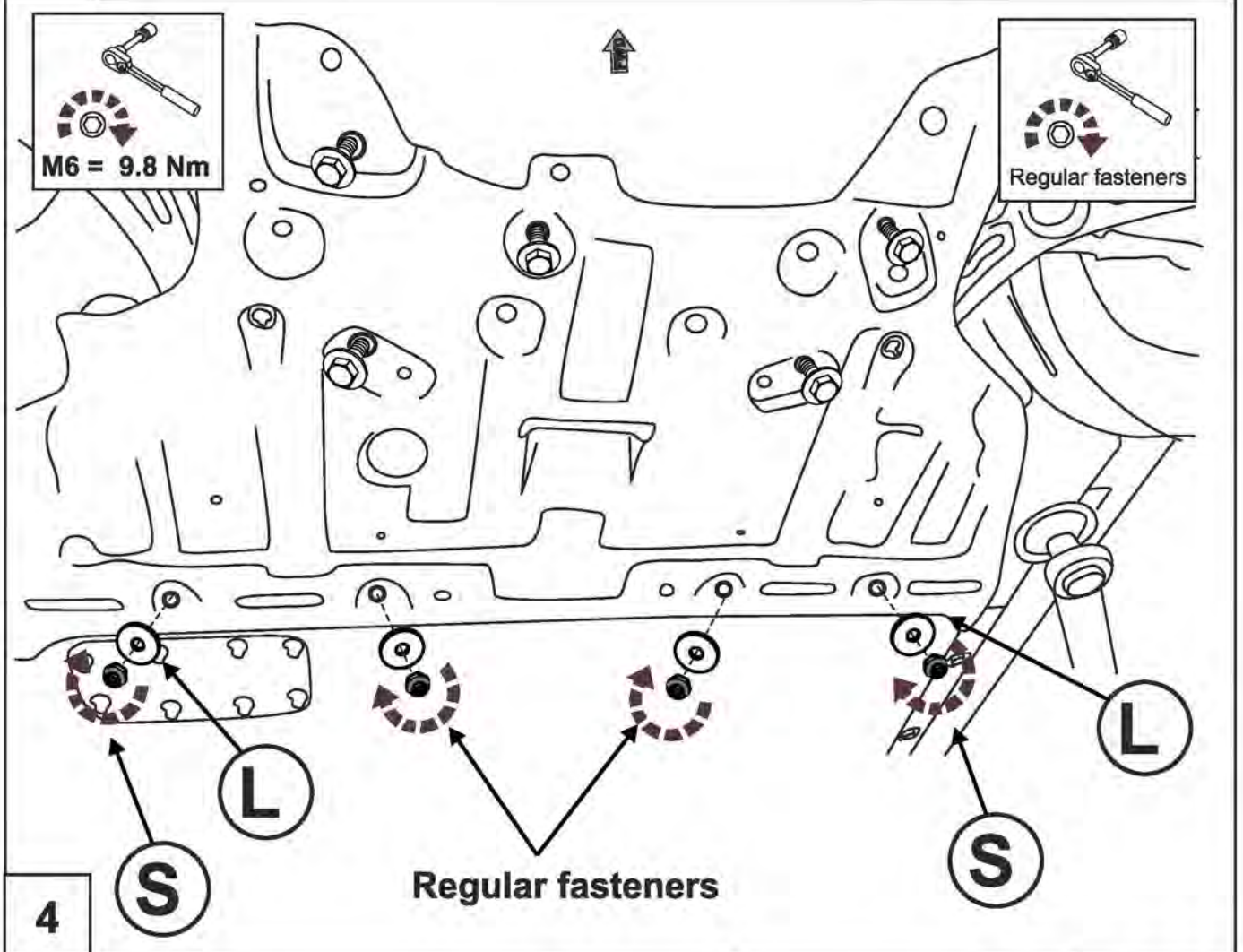
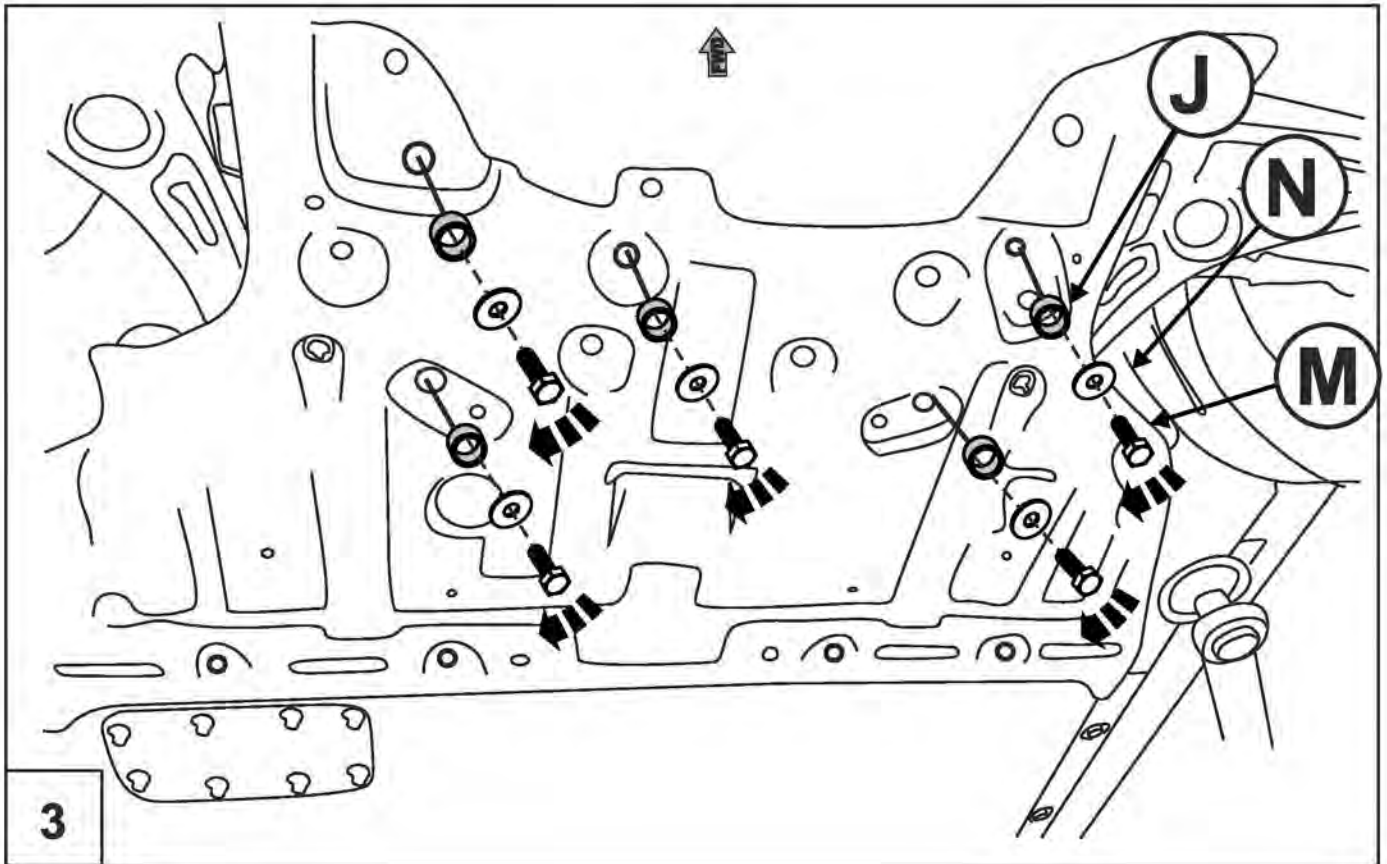

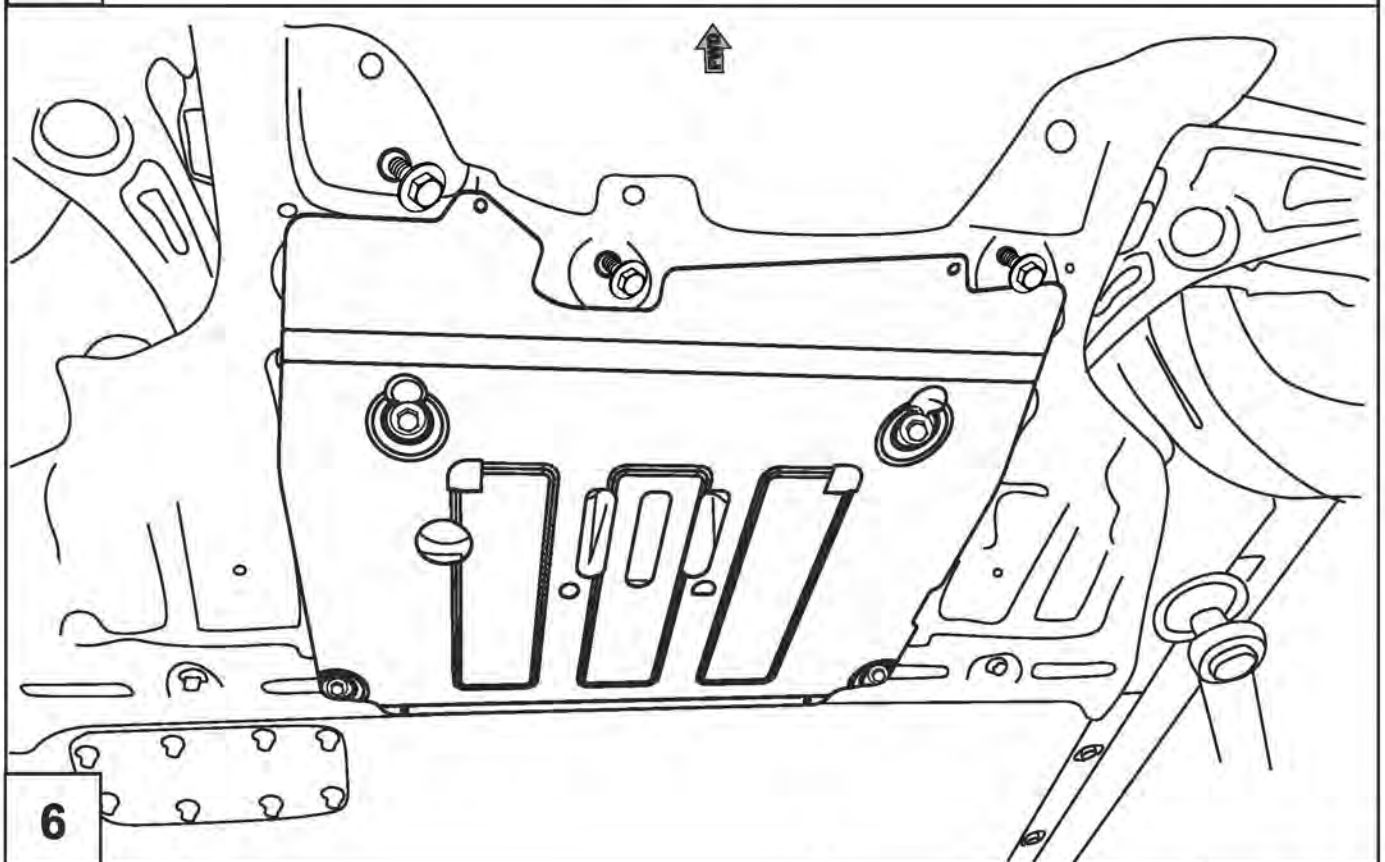
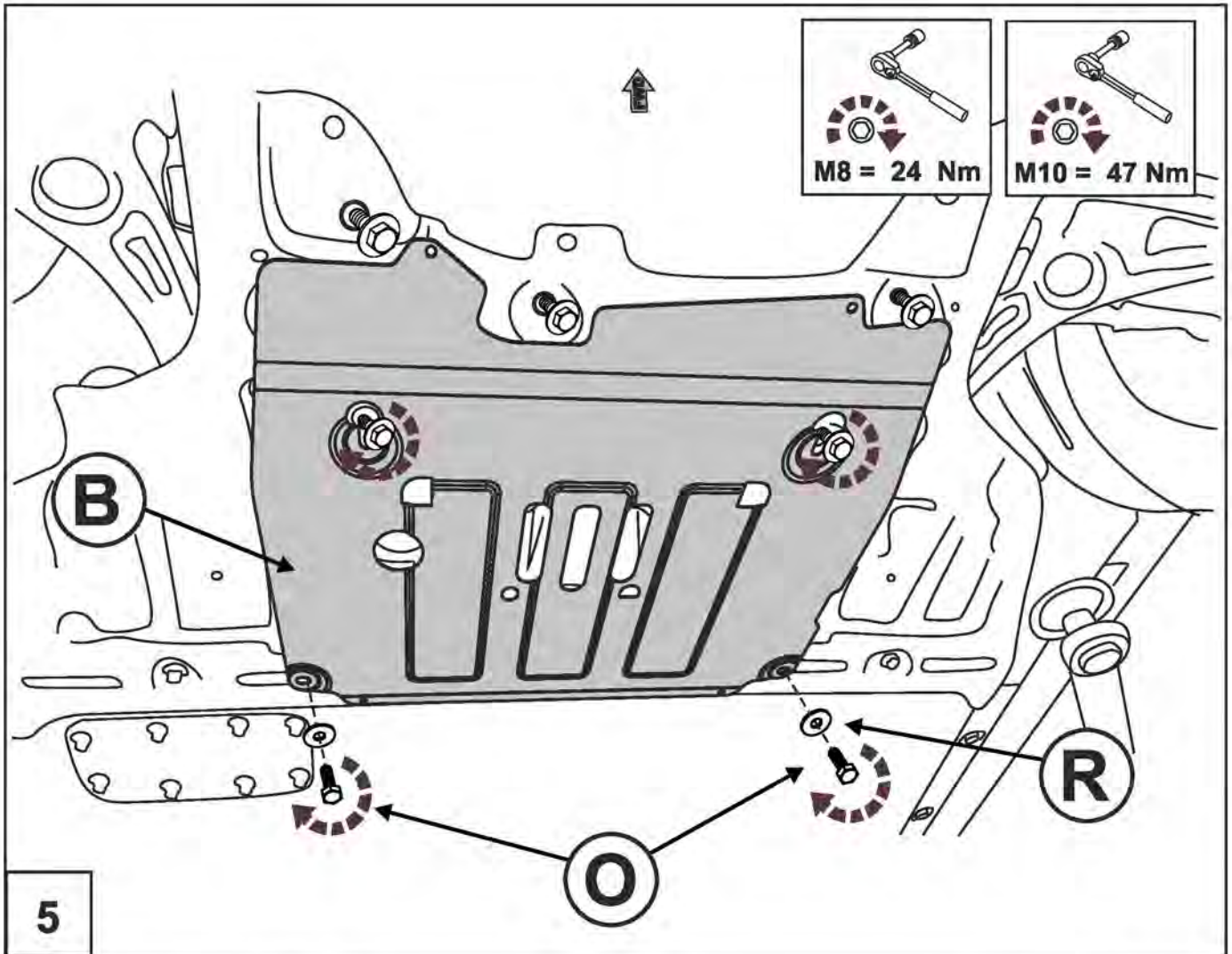

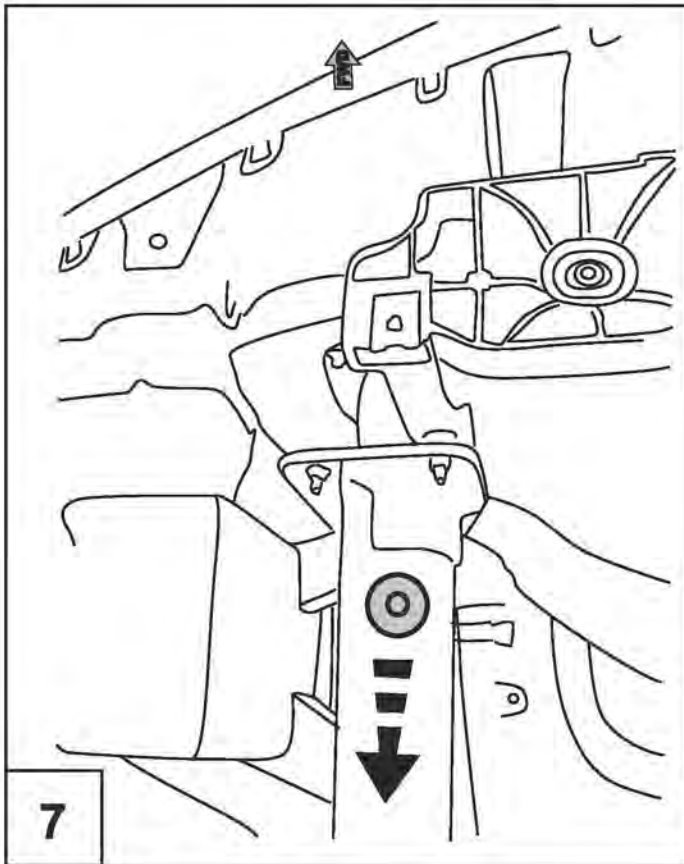

7

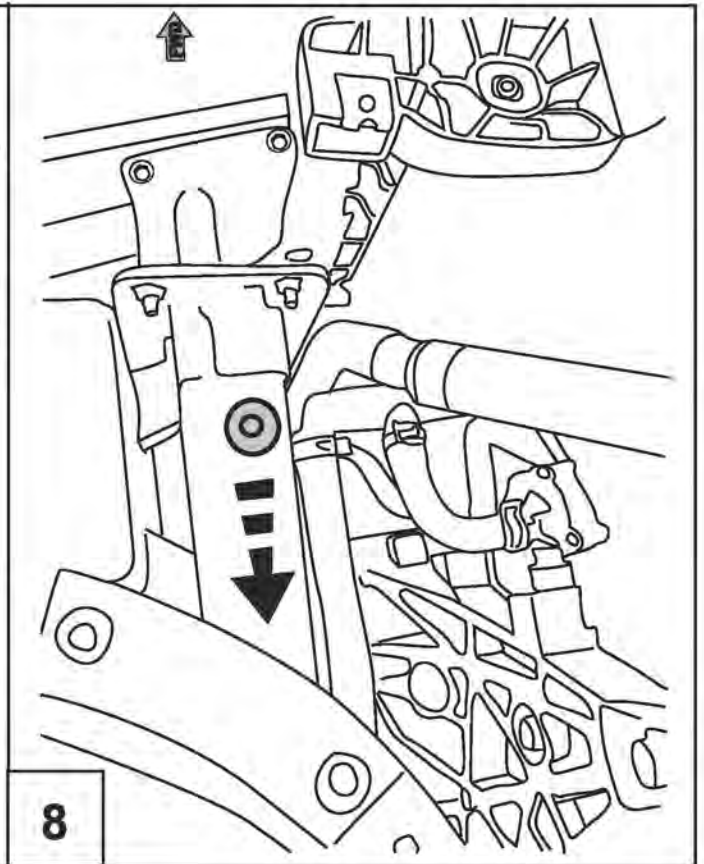

8

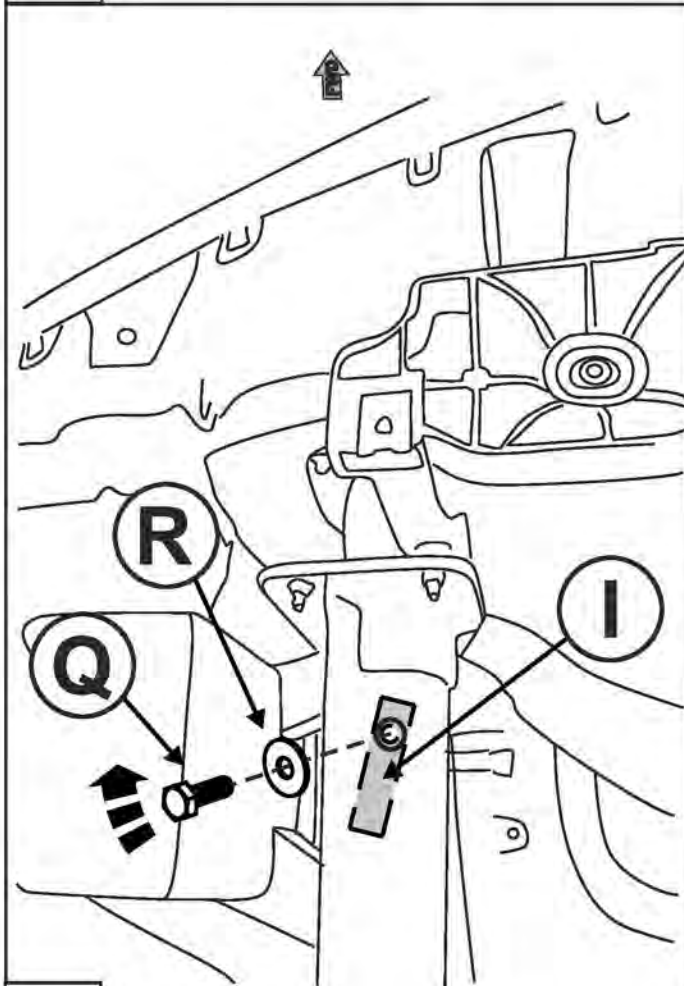

9

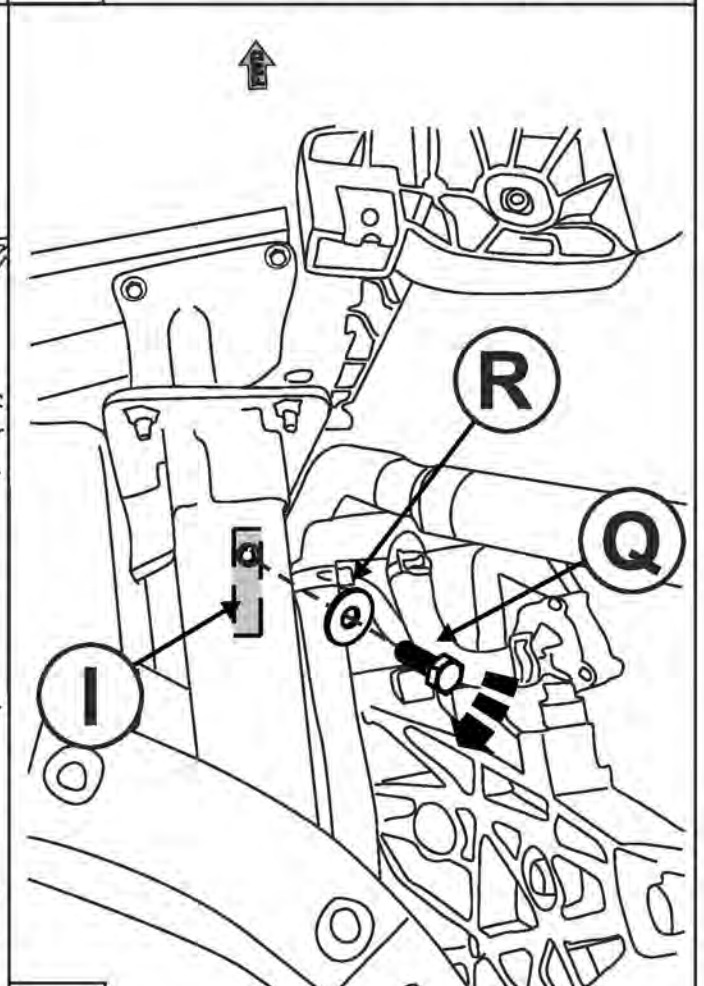

10

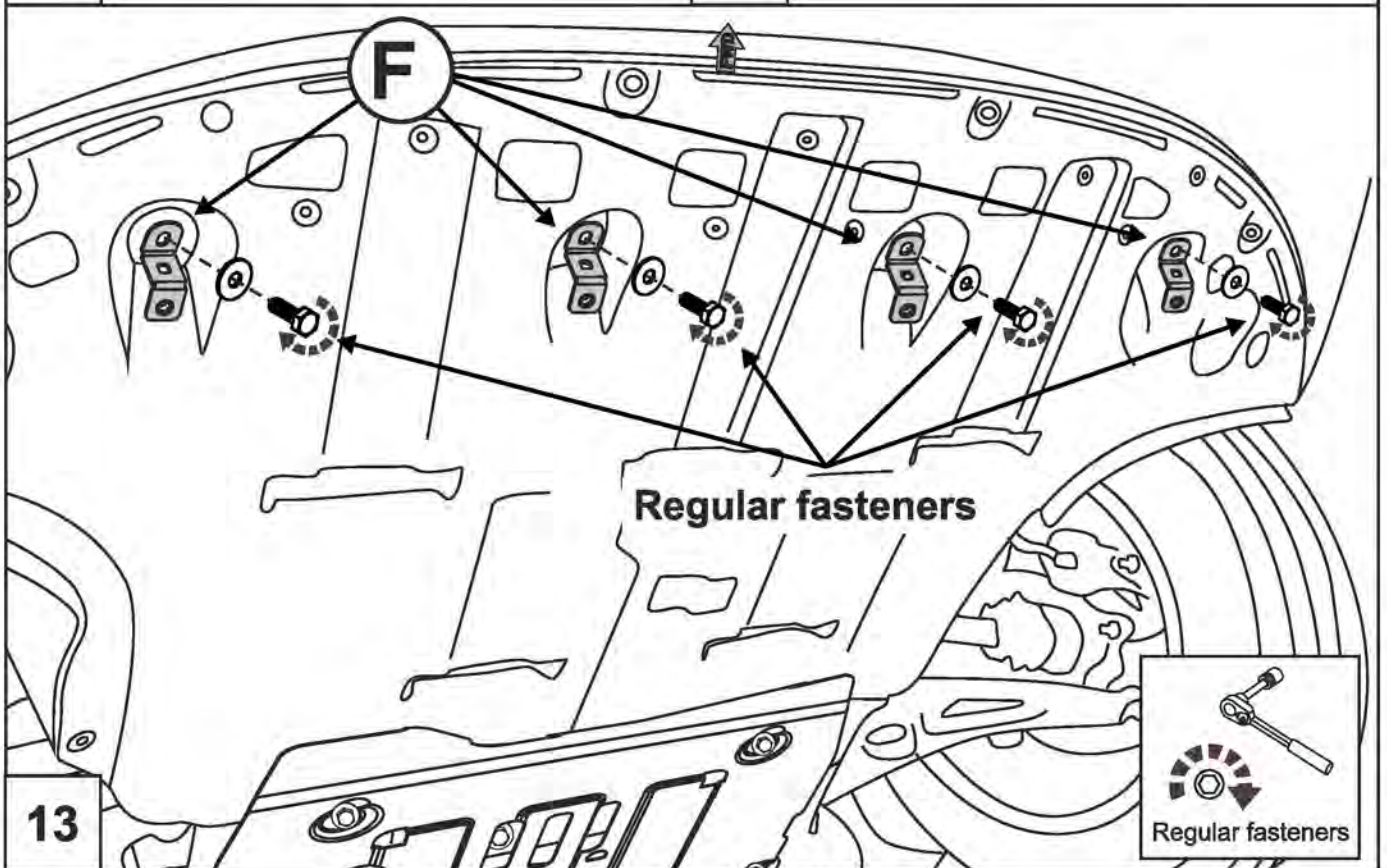
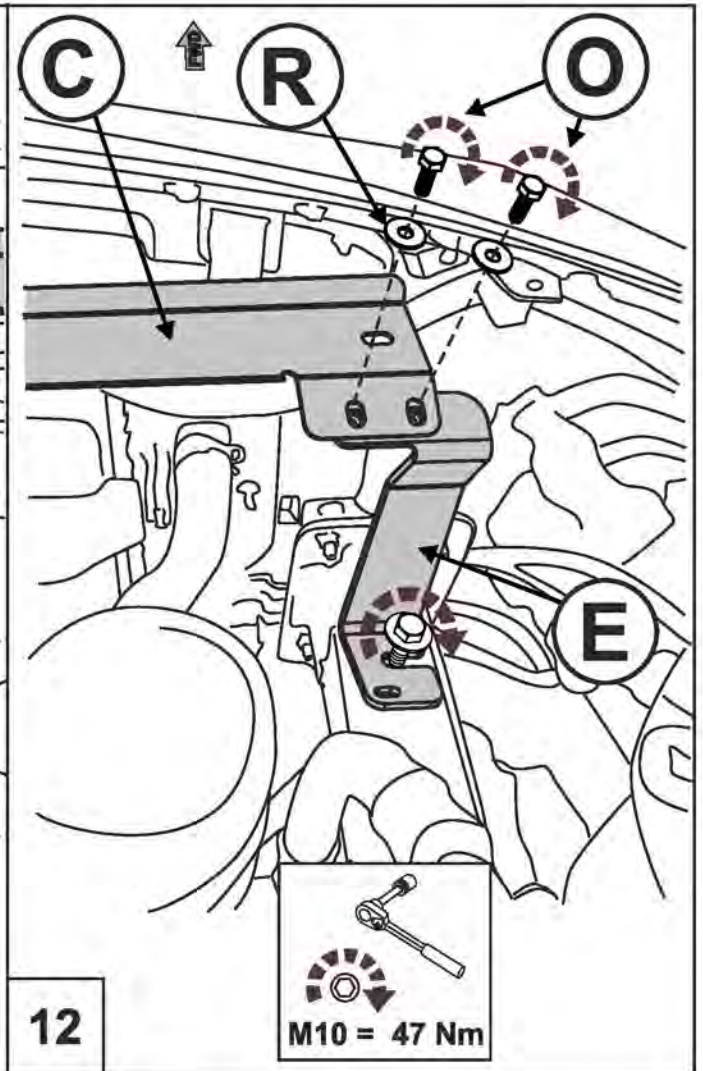
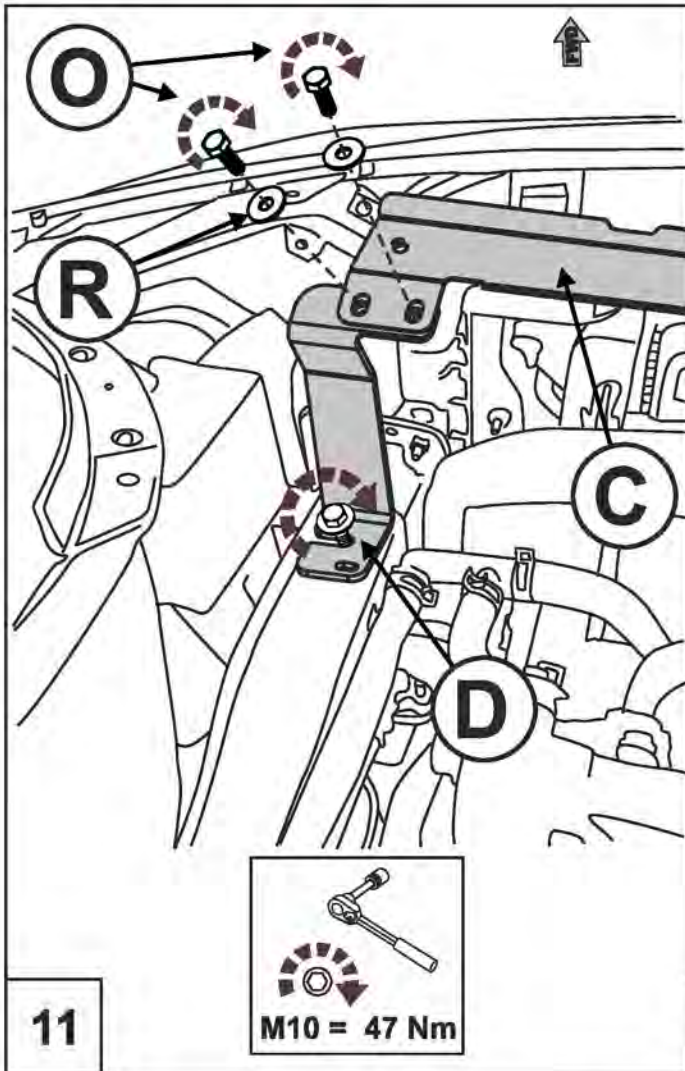

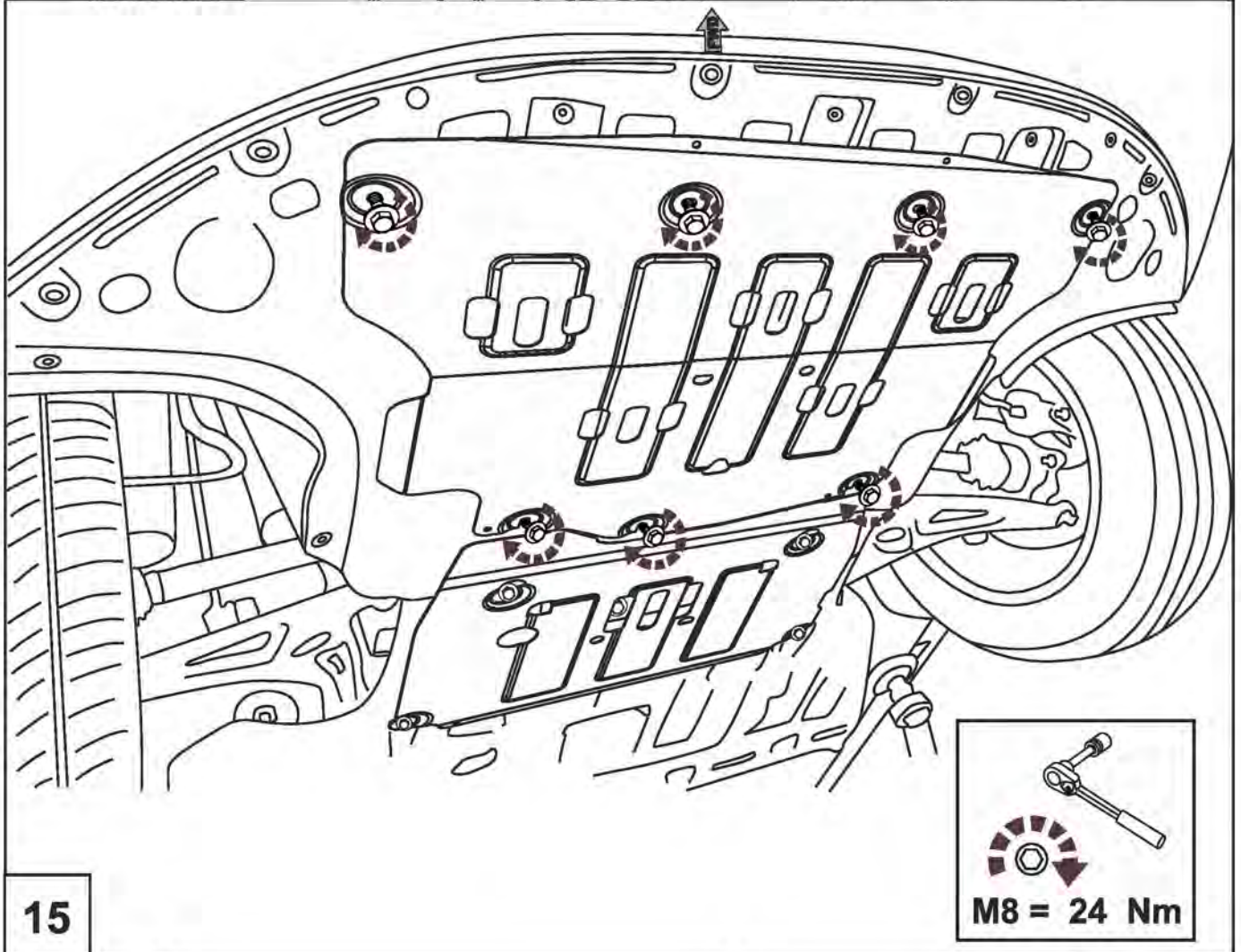
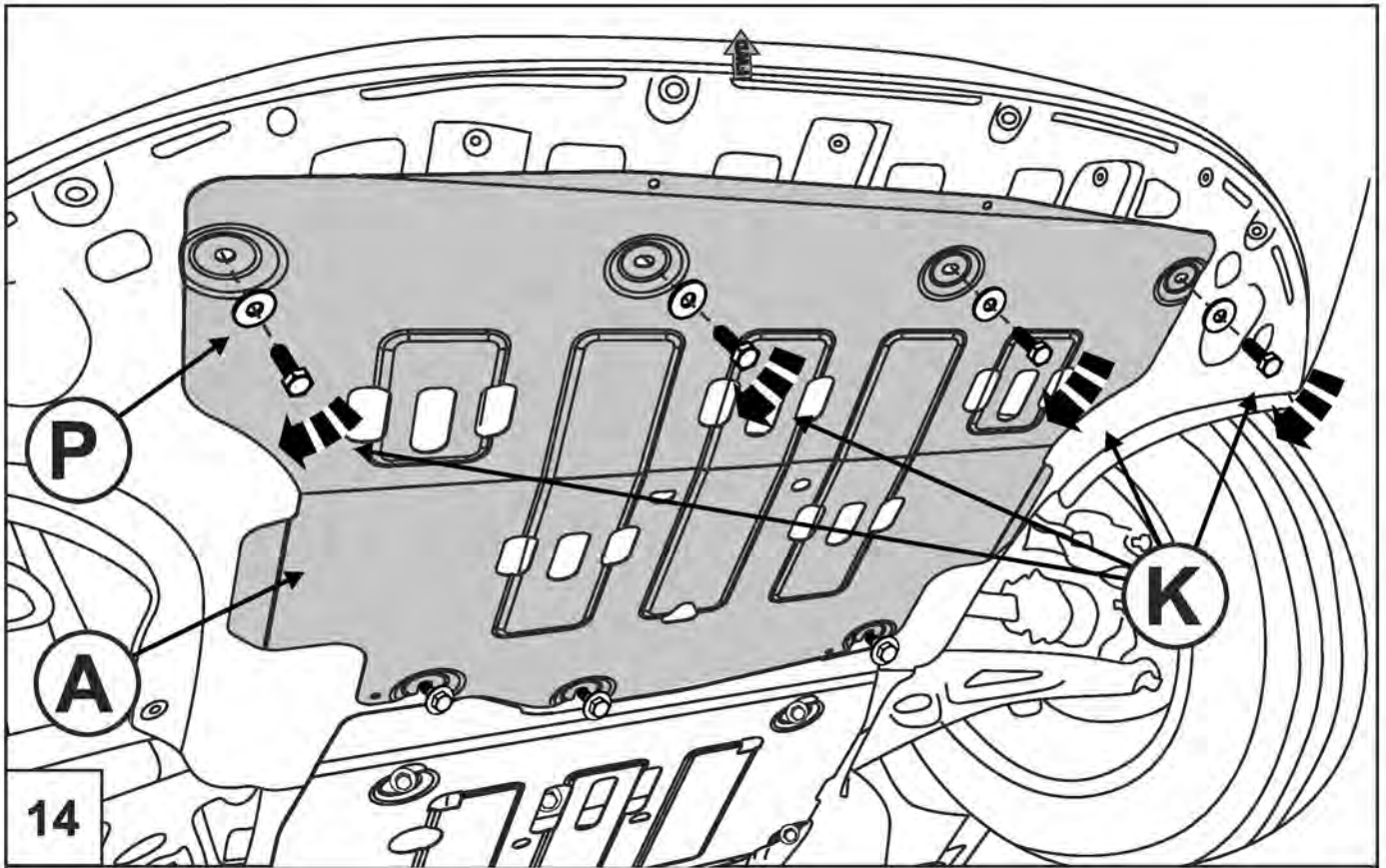

INSTALLATION:

Engine bay and transmission elements skid plate has been designed particularly for a certain vehicle. It should be mounted according to the producer's installation instruction by a dedicated dealer or on certified service stations. The skid plate is fixed to regular apertures located on vehicle's body load-bearing elements. In case of correct installation the skid plate should not interfere with any vehicle's units and components.

OPERATING CONDITIONS:

Engine bay and transmission elements skid plate has been designed to operate in conditions specified by vehicle's producer. Cases of crush or driving into obstacles at a speed should be excluded during exploitation. In case of head-on crush it is necessary to assure in absence of damages of vehicle's components and units and availability of roadworthiness on certified service stations.

ENVIRONMENTAL PROTECTION

Dispose of packaging properly. It is recommended to take it for recycling. Don't forget about environmental protection.

